

Skinny F327S

3G MOBILE PHONE USER MANUAL

Search 'ZTE Australia' on Facebook , Google+ and Twitter to keep in touch.



WHAT'S INSIDE

- 03 Getting Started
- 06 Get to know your mobile phone
- 13 Calls
- 17 Contacts
- 19 Messaging
- 25 Settings
- 26 Media Player
- 27 Email
- 29 Quick Reference Features
- 33 Troubleshooting, Technical and Warranty
- 37 Technical Specifications
- 40 Extra bits you should know

This phone is suitable for use on the Skinny network. It supports UMTS 850 only and is not suitable to use on other carriers.

GETTING STARTED

1. REMOVE THE BACK COVER

- Use the thumb catch at the bottom left on the back to open the battery cover.

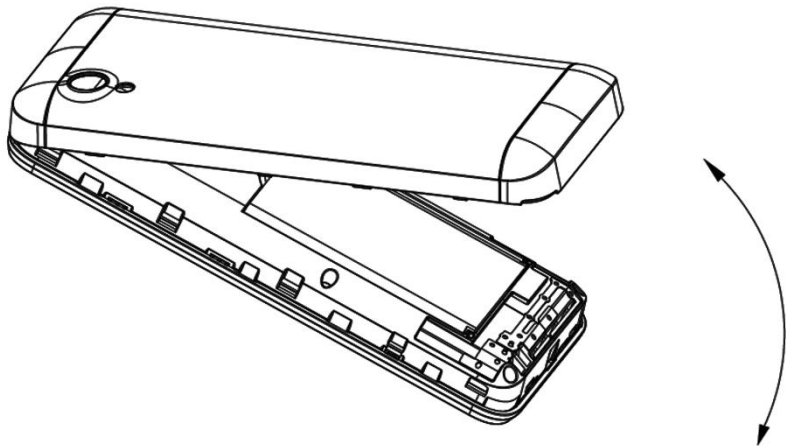

2. INSERT THE SIM CARD (STANDARD SIZE)

- Insert the SIM card with the gold contacts facing down and the slanted edge on the top left as shown:
- This phone uses a Standard sized or 2FF SIM Card.

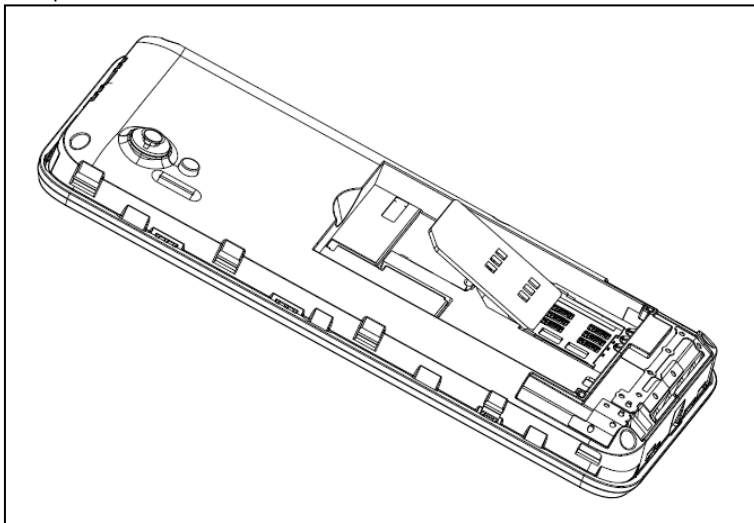

3. INSERT THE BATTERY

- Press the battery down flush into the case lining up the gold contacts and pins.
- Replace the battery cover and press gently to close the case.
- Press and hold the Red power key to power your device on and off.

4. CHARGING YOUR HANDSET

- Plug the micro USB cable in to the handset
- Plug the other end of the cable into the AC adapter and plug the adapter into an electrical outlet or USB port on your computer
- The plug and socket are shaped so they will only fit together one way.

Important Notes:

Only use the AC charger and USB lead supplied. Insert the lead carefully. Check the plug and socket are aligned correctly.

Do NOT use excessive force which may damage the USB port.

Be careful to avoid tripping on the lead whilst it is plugged in.

Physical damage to the USB port is NOT covered by warranty.

Normal charge time is 3-4 hours.

Do not leave on charge for more than 24hrs.

Charge the battery between 0°C~45°C. Charge the battery promptly when flat.

With poor network conditions (less than 2 bars) battery life is reduced.

When not using the phone for long periods remove the battery.

GET TO KNOW YOUR MOBILE PHONE



Headset port USB Charging port



UNLOCK THE SCREEN

- **To unlock**, press the power key to wake up the screen
- Press and hold the * Key to **Unlock (Long press *)**
- To lock the screen press and hold the * key
- Go to Menu > Settings > Phone Settings > Display > Screen auto lock to change the timer or switch this on or off.
- Whenever the screen is locked a message will appear in the centre of the screen telling you how to unlock the device.
- When the screen and keypad are locked it is still possible to dial the Emergency Services, so be careful not to activate the keypad or press the device against hard objects in your bag or pocket.

Handy Hint:

To adjust period of time for the screen lock or switch auto screen lock on or off go to Menu > Settings > Phone Settings > Display > Screen auto lock

NAVIGATION KEYS

- From the Home screen press the navigation keys to launch the default shortcuts:



- During a Call the left and right navigation keys will adjust the in call volume
- Press the Right Soft Key to activate Speaker mode during a call.

Handy Hints:

The arrow key shortcuts can be set to your own preferences.

To change default shortcuts go to: Menu > Settings > Phone Settings > Shortcut

Main Menu Tip

Each menu item is laid out on a grid so you can press the corresponding key on the keypad as a shortcut to the menu item. Example, pressing Menu 1 from the home screen takes you to Contacts. Pressing Menu 6 takes you to Settings.

MENU QUICK REFERENCE GUIDE

Menu 1

Contacts	Messages	Calls
E-mail	Browser	Settings – see below
Camera	Media	FM Radio
Images	Recorder	Files



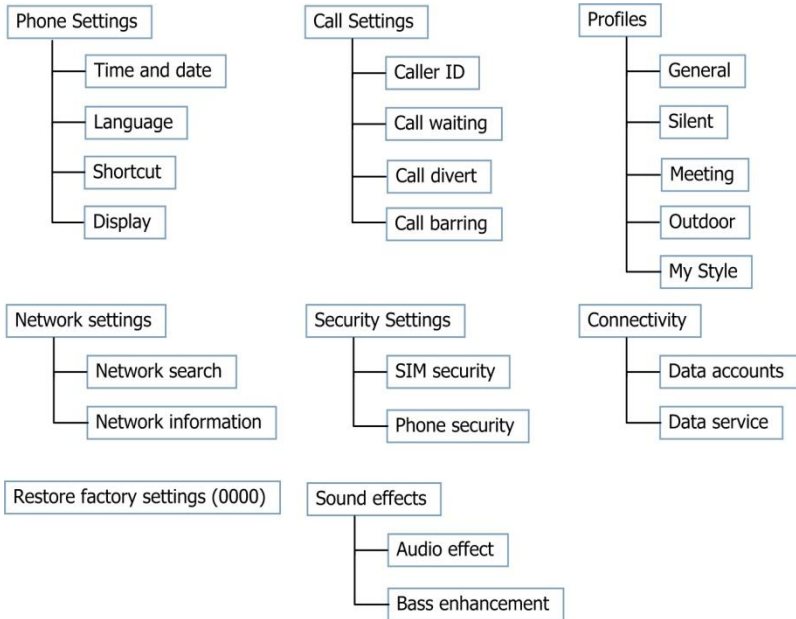

Menu 2

Bluetooth	Calendar	Alarm
World Clock	Notes	Calculator
Tasks	Convert	Torch
Stopwatch	SIM	























SETTINGS MENU



KEY FUNCTIONS



Indicator	Description
	Power Key – hold down to power On and Off Press to End a Call. Press to Exit a menu and return to the idle screen
	Call Key - After entering a number press to make the call Press to access the call logs Press twice for last number redial.
	Press OK to access the Main Menu and confirm menu selections
	Unlock – Press and hold * to unlock
 Key	Long press (press and hold) to get the International dialling prefix (+) and Pause and Wait dialling modifiers
Volume	Press the left and right navigation keys
Soft Keys	The left and right soft keys perform the task shown on the screen corresponding to their respective locations.



STATUS ICONS

 Network signal level	 Alarm is set
 No Network	 Bluetooth On
 Connected to 3G	 Missed Call
 Connected to 2G	 Received SMS
 HSDPA Data	 Received MMS
 EDGE Data	 Outgoing Message
 Battery level	 Screen is locked
 Vibrate then ring	 Roaming
 Ring only	 Speaker is muted
 Vibrate only	 Active Call
 Silent	 Call is on Hold

CALLS

There are 3 ways you can make a call on your phone:

1. Enter the number on the keypad, if you know the number
2. Select the left soft key to access Contacts, select the number then press OK or the Green key  to call directly
3. Press the  button to access the call log to use your call history to call.

Whichever way you choose, press the green key  to make the call, press the red key  to hang-up.

During a call press the right soft key to enable Handsfree or Speaker-phone mode.

Handy Hint:

You can use the left and right arrow keys on the navigation key pad to increase or decrease the volume when in an active call.

HOW TO ANSWER AN INCOMING CALL

There are two ways to answer an incoming call:

- Press the green key  answer the call
- Press the red key  or Reject to end the call.

Handy Hint:

If you would like to silence an incoming call without rejecting it, press the down arrow on the navigation keypad or the right soft key for Silence.

HOW TO CHANGE THE SCREEN BRIGHTNESS

The default screen brightness is set to the middle setting. This will allow you to get the maximum possible out of your battery.



- To change this setting Select Menu> Phone settings > Display > LCD Backlight

Important Note:

Increasing the brightness of the screen will have an effect on the battery power consumption

CALL FEATURE SUMMARY

The table below is a quick summary of call features

Function	Description	Menu Selection
Call Barring	Restrict various categories of incoming or outgoing calls.	Menu > Settings > Call settings > Call barring
Call Divert	Forward incoming calls to another number.	Menu > Settings > Call settings > Call divert
Call Waiting	If you are already on the phone you hear pips to indicate another incoming call. Press Options to switch between the two callers.	Menu > Settings > Call settings > Call waiting
Last number redial	Press the Green Call Key to bring up the Call log Press again to dial the first number in the list or scroll down to the number	Call Key  , then Call Key 
Send my number	Show or hide your number when making calls.	Menu > Settings > Call settings > Caller ID

Set Speed Dial	Set your Contacts to be called directly from the idle screen. Long-press the number to dial.	Menu > Contacts > Options > Phonebook settings > Speed dial
Speakerphone	Use hands-free or in loud speaker mode.	During a call press the right soft key H-Free. Or Options > H-Free
Speed Dial Call	Press and hold the corresponding key on the number pad to quickly call a Speed Dial Contact.	From the idle screen press and hold a number key. 1 is preset to Voicemail.
Volume	Use the Left and Right navigation keys to adjust the volume during a call	During a call press the Left / right keys
Insert a Pause or Wait character while dialling	'P' inserts a 3 seconds delay. 'W' waits indefinitely until you enter the next character. Used for call centres and phone banking applications.	When dialling manually press and hold the + key for a Pause or Wait. 'P' and 'W' can also be saved in Contact numbers.

CONTACTS

There are some numbers that you may want to call again and again so it makes sense to add these to your Contacts.

You can then access these numbers quickly and easily and add special features such as Speed Dialling, a dedicated Ringtone or a Photo.

Function	Description	Menu Selection
Add a Contact from a received call	Access the Call log and create a new Contact from an incoming call record	Press the Call Key  > Select the call record > Press Options > Save to Phonebook
Add a Contact from an SMS	Go to your Inbox and select the required SMS.	Options > Advanced > Use number > Options > Save to Phonebook
Copy Contacts to and from a SIM card	Copy Contacts from the SIM into the handset or handset to SIM	Menu > Contacts > Options > Copy > To SIM / To phone

Delete a Contact	Select the Contact then press Options	Menu > Contacts > Options > Delete
Enter a new Contact	Save a number you have just dialled as to a contact	Enter the number > Options > Save to Phonebook > Follow the prompts
Search your Contacts	Search Contacts to find a particular person.	Menu > Contacts > Scroll down or press a letter key to search
Set a Contact image	Add a photo or unique ringtone to a Contact (must be stored on phone)	Menu > Contacts > Options > Edit > Scroll right to add a Caller picture or Caller Ringtone and press Add.

MESSAGING

You can stay connected by using your mobile to send messages, multimedia messages and emails to your family and friends.

Important Note:

If your text message exceeds 160 characters you will be charged for multiple text messages.

Letters, symbols and spaces count as characters.

HOW TO CREATE A TEXT MESSAGE (SMS)

- Press the Left Soft Key as the shortcut for Messages (SMS) or select Menu > Messages > Write Message (OK)
- Follow the tips below to add Contact(s), and to send your message.

HOW TO ADD A CONTACT TO A TEXT MESSAGE (SMS)

- Press the Left Soft Key as the shortcut for Messages (SMS) or select Menu > SMS > Write Message
- Enter the phone number directly or press OK key to select a contact manually from your Contacts
- Scroll to the chosen contact(s) and OK
- At this point you can select multiple contacts by scrolling through your list and pressing OK
- Press Add once all your contacts have been added

HOW TO ADD TEXT TO YOUR SMS

Once you have added your contacts you are ready to add text and send your message.

- From the contacts field, press the Down Arrow once to move the cursor into the text field
- Type the message using the letter keys on the keypad (see next heading)
- Press OK to send or Back to save to Drafts and send later.

Handy Hint:

Press the # key to change between predictive text (Smart Abc) and standard typing modes.

In Multi-tap modes (Abc/ABC) if the next letter is on the same key, wait until the cursor appears or press the Right arrow.

HOW TO TYPE USING THE KEYPAD (abc, Abc & ABC modes)

- The letters of the alphabet are arranged on the keys from 2-9
- Press the # Key to change letter entry mode shown in the icon bar at the top of the handset. S indicates Smart text entry for predictive text.
- Whenever you are in text entry mode, to enter a name, send a message or write a note, the handset will automatically change to letter mode
- The letters written on the number keys are entered depending on how many times you press the key. This is called multi-tap mode. For example, to write the name John, you press
 - the 5 key once for J,
 - then press the 6 key three times for O,
 - press the 4 key twice for H and
 - then the 6 key twice for N
- To insert a space press the 0 key
- If you have made a mistake and want to delete letters press the Clear key

- Press the 1 key for common punctuation marks
- Press the * key for special characters
- Long press the key to enter the corresponding number.

Important Note:

? € \ [] { }	Each time one of these symbols is used 2 standard SMS characters are transmitted.
...	This symbol is not part of the standard SMS character set. Each time one of these symbols is used the entire message is converted to Unicode. The maximum number of Unicode characters per SMS is 70.

HOW TO VIEW A RECEIVED TEXT MESSAGE

The envelope icon  on the information bar indicates a new SMS message has been received

- Along with this, depending on the current profile setting, a message alert tone and vibrate activate will be heard
- The display of the phone will also show that a new message has been received
- To view, press centre key to view message

HOW TO SEND A MULTIMEDIA MESSAGE (MMS)

Sending a MMS is similar to a text message. The main difference is adding media. This can be done by selecting Options > Insert > Choose from My Pictures, Take picture etc...

Use a Multimedia Messages to send attachments such as pictures, music or video files. You can also send an MMS directly to an email address, this could be handy to share your photos for example.

- Select Menu > Messages > Write Message
- Enter the phone number, or press centre key for Contacts
- Press the down arrow to enter the main message body
- From the text area press Options > Insert > Add picture sound or video
- Browse the folders to select the required file. Press OK
- When finished press OK to Send
- Each 'page' can only contain one image, one audio, or one video file.

Handy Hint:

To add more than one file select Options to add a new page

HOW TO RECEIVE A MULTIMEDIA MESSAGE (MMS)

When a new MMS has arrived you see a pop up notification on the main screen.

- Press OK key to View
- Press Retrieve to download the message attachment
- When the attachment has downloaded if you would like to save the attachment press the Left Soft Key for Options
- Choose Use Item to Save the file into File Manager

Important Note:

You need to have data enabled on your SIM service to send and receive MMS messages.

If you find you are not able to download the MMS at that point in time, retry later. Confirm MMS is enabled and active on your account

WAP PUSH MESSAGES

WAP Push Messages are indicated on the main display.

- Use the Browser to view Push Message or Reject the message
- Go to Menu > SMS > Settings > Service message > Enable Push > Accept or Disable to change the setting to receive WAP push or disable.

BASIC SETTINGS

SET THE TIME AND DATE

The time and date is set automatically from the network. It takes a few seconds to update when the phone is first switched on.

Handy Hint:

Select Menu > Settings > Phone Settings> Time and date to change manually

CHANGE THE RINGTONE

To personalise your ringtone follow these few simple steps:

- Select Menu > Settings > Profiles
- Use up and down arrow keys to scroll through to the profile you would like to change
- Press left soft key Options > Customise to change the selected profile

From here you have the ability to change your default ringtone for this profile, along with, video call tone, change the ring volume, message tone, keypad sounds.

ADJUST RINGTONE VOLUME

Change the default volume for any of the profiles

- Select Menu > Settings > Profiles
- Press left soft key Options > Customise the current profile
- Scroll down to Ring volume
- Press left and right keys to set the volume
- Press centre key to Save the change

EMAIL

Your handset has been set up with some common service providers, you need to add your email account to be up and running in no time.

- Select Menu > Email > Yes to add a new email account.
- Scroll down to your email provider then Click OK to select.
- You will now be in the Mailbox setting
- Complete the required fields to add your account
- Select Menu > Email > Settings > Mailbox Settings > Options > New to add a new Mailbox or to set up alternate email providers.

Important Note:

You may need additional information from your Internet Service Provider (ISP) if registering an email provided by your ISP or other email service provider that is not in the list.

- Menu > Email > Select Email Account > Write Email
- Enter the email address e.g. username@domain.com. Press centre key to input address from contacts
- Press the down arrow to access the Subject Field
- Press the down arrow to enter the Text Field
- Press left soft key > Options to Insert attachments if required
- Browse to the appropriate folder to add the attachment
- When you are finished press the centre key to select Ok to Send.
- Press the right soft key to go back to the previous screen at any time.

HOW TO RECEIVE AN EMAIL

- Menu > Email > Select Email Account > View > Inbox > Retrieve
- New Email messages are delivered to the handset

HOW TO SET UP AUTOMATIC RETRIEVAL

- Menu > Email > Select email account > Options > Edit > Advanced Settings > Account settings > Check interval
- Set your required time interval to check the server for new Email messages.

MEDIA PLAYER

- Press Menu > Media to open.
- Press the Left Soft Key for Options > Main Menu > Music, Movie etc.
- Press Options Add from Folder to import any music on your device.
- See Connect to a computer to import music files from your PC

CONNECT TO A COMPUTER

Plug your device into a computer using the USB lead provided. The handset will show a list of options to connect.

Use Mass Storage mode to transfer files to and from the handset.

Example:

To save a picture from your handset, plug in > Mass Storage Mode > On your PC open Windows Explorer and browse to the handset > Photos folder. Copy the photos to your PC.

This device supports the Windows and MAC OS. MAC uses Mass Storage mode as a file system browser and Windows also supports MTP mode.

QUICK REFERENCE FEATURES

Function	Description	Menu Selection
Alarms	Set and edit Alarms	Menu > Alarm > Edit.
Back Function	Go back one screen	Press the right soft key
Backlighting	Set the backlighting duration	Menu > Settings > Phone settings > Display> LCD backlight
Bluetooth	Connect to Bluetooth wireless headsets	Menu (scroll right) > Bluetooth > Switch On, Enable visibility, Search for devices.
Brightness	Change the display brightness	Menu > Settings > Phone settings > Display> LCD backlight
Calculator	Apply basic maths calculations	Menu > Calculator
Calendar	View and set calendar events	Menu > Calendar
Call log	View all calls history	Menu > Calls or press the Call Key
Camera	Use the Camera	Press the Up arrow key or Menu > Camera TIP: Connect your phone to a PC then select Mass Storage or MTP to transfer pics.

Delete Text	Press the Clear key (Right soft key)	Clear key for delete, in any text mode.
Edit Images	Rotate, add effects etc	Menu > Images > Options > Edit
File Manager	View and manage your files	Menu > Files
FM Radio	FM Radio on your phone	Menu > FM Radio. Press Left Soft key for Options > Auto Search. Use * and + for Volume controls
Keylock	Set timer to lock the keypad. Default is 60 seconds	Menu > Settings > Phone settings > Display > Screen auto lock
Keypad Light	Set the Keypad Backlighting	Menu > Settings > Phone settings > Display > LCD backlight
Keypad Sounds	Select the keypad tones	Menu > Settings > Profiles > Options > Customise > Keypad > Options > Save
Lock Code	Switch on the Handset Lock code to protect the Handset. The default code is 0000	Menu > Settings > Security > Phone security > Phone lock (0000)

Message Tone	Change the incoming message tone	Menu > Profiles > Options > Customise > Message > Options > Save
Media	Play your audio files	Menu > Media
PC Connection	Connect your phone to a PC to browse photos and other files	Connect your phone to a PC then select Mass Storage to view device storage.
PIN Code	Set your start up PIN code	Menu > Settings > Security settings > Phone security > Phone lock (0000)
Profiles	Group handset behaviours for ringing, vibrate etc.	Menu > Settings > Profiles > Options > Customise
Restore Defaults	Restore your phone to factory default settings	Menu > Settings > Restore factory settings > 0000
Ringtone	Change the incoming ring	Menu > Profiles > Options > Customise > Incoming Call > Options > Save
Shortcut Keys	Customise the four arrow keys to your preferred features	Menu > Settings > Phone settings > Shortcut

Silent mode	Silence the incoming ring and all other sounds	Menu > Profiles > Silent
Speakerphone	Use hands-free or loud speaker mode.	During a call (or call set-up) press the right soft key (H-free) for Speaker
Stopwatch	Activate the Stopwatch timer	Menu > Stopwatch
Torch	Use the handset as a torch	Long press on the OK key, or Menu > Torch.
Vibrate Mode	Switch on vibrate mode	Menu > Profiles > Options > Customise > Alert type> Options > Save
Video Camera	Use the Video Camera	Menu > Camera > Down arrow
View Pictures	View your photos	Menu > Images
View Videos	View your videos	Menu > Images
Voice Recorder	Record voice memos	Menu > Recorder
Wallpaper	Set your background image	Menu > Settings > Phone settings > Display > Wallpaper
World Time	Access the World Time function	Menu > World clock

TROUBLESHOOTING, TECHNICAL AND WARRANTY INFORMATION

TROUBLESHOOTING AND FAQ'S

Please check the manual thoroughly before contacting Skinny.

Symptom	Solution
How do I reset to factory defaults?	Menu > Settings > Restore factory settings > 0000
How do I find the SMS Service Centre number	Menu > Messages > Message Settings > Text message > SMS centre (Skinny is +61418706700)
How do I configure the MMS Settings?	Menu > Messages > Message Settings > Multimedia message
How do I configure Email settings?	Menu > Email > Select email account > Options > Edit
How do I copy Contacts to or from my SIM card?	Menu > Contacts > Options > Copy
How do I manually select a carrier?	Menu > Settings > Network settings > Network Search > Manual

Symptom	Solution
How do I change the APN	Menu > Settings > Connectivity > Data accounts. Use Options > Restore default to set back to Skinny
How do I enable data roaming	Menu > Settings > Connectivity > Data roaming
How do I clear my Browser?	Menu > Browser > Internet service > Settings > Browser options > Clear cache, Clear cookies, Clear history
How do I check Call forwarding etc	Menu > Settings > Call settings > Call divert
How do I update the handset	Menu > Settings > Software update
No incoming ring or alarm tone	Check the ring tone and ring volume settings under Profiles.
(No) keytones when pressing keys	Check the key tone settings in the current profile. Menu > Profiles > Options > Customise
How do I change the Ringtone?	Edit the current profile and select a new tune from the Audios directory.
A phone number cannot be dialled	Check you have a valid SIM. Check for network coverage. Check whether any call restrictions are set. Menu > Calls > Call settings > Call barring.

Symptom	Solution
MMS messages cannot be sent or received.	Your phone may not be setup with correct network settings, contact Skinny to setup. This type of content may be restricted by your service.
How do I change to Predictive Text?	Press the # key to bring up the available text formats, select S Abc for smart text.
The handset switches on by itself.	An alarm or calendar event switches the handset on automatically.
My phone is slow to respond, handset storage problems	Power cycle your phone to refresh the memory. Delete old SMS messages and other content. Restore default settings: Menu > Settings > Reset factory settings > 0000
The battery discharges quickly	Possible network coverage issue. Check the signal level. With only 1 or 2 bars, the battery has to work harder to maintain network contact. Limit multi-media to save power. The battery may be worn out.
I cannot charge the phone	Confirm the charger is properly inserted. Remove the battery, clean the contacts and check it is inserted correctly. The battery may be worn out. Tips: Always use the supplied USB cable. You can charge from any standard USB port.

Symptom	Solution
How do I write an SMS?	Menu > Messages > Write message From the phone number field press the down arrow to move into the text area. Use predictive text or abc mode to type words using the keypad
The handset switches off after charging.	The handset is charging in the off state. Press and hold the Red key to switch the handset ON.

ERROR MESSAGES

Message	Solution
No (U)SIM detected	Check a valid (U)SIM card is inserted See Getting Started
Enter PIN code	Enter the correct PIN code supplied by your service provider
Enter PUK code	Contact Skinny to get the PUK code
Enter handset lock code	The default handset lock code is 0000

TECHNICAL SPECIFICATIONS

Network Compatibility	3G UMTS 850 with 7.2Mbps data
Dimensions LxWxH	Approx 119.5mm x 50mm x 14.1mm
Weight	Approx 86g (Including standard battery)
Features	MP4 video, MP3 audio, 80KPixel rear camera, USB, 2.4" 65K colour TFT display with 240 x 320 pixels, MMS, Email, Calendar, Speakerphone, Voice Recorder, 3.5mm audio jack, CTM, approx 43MB user memory, Bluetooth 2.0
Battery	1000mA hours, Lithium ion (Li-ion)
Standby time*	Up to 180 hours
Talk time*	Up to 180 minutes talk time. Video call >70 minutes
Charge time	Approximately 3-4 hours
Battery Life	Approximately 400 charge cycles
Supported Files	JPG, BMP, GIF, MP3, WAV, MID, WMA, MMF, AMR, MP4, 3GP, TXT

Important Note:

Talk and idle times are based on ideal network conditions.

The use of applications and local network conditions can reduce battery life.

SUPPORT INFORMATION

- For Warranty Service directions please consult Skinny. You can also contact ZTE through Facebook for support and troubleshooting assistance.
- All calls for PIN number enquiries, Network problems, Web Access, Account and Billing Information, (U)SIM card registration and other general enquiries should be directed to your Service Provider.
- Your device is locked to the Skinny network. Please contact Skinny to obtain the unlock code and instructions.

WARRANTY INFORMATION

The warranty does not apply to defects or errors in the product caused by:

1. Normal wear and tear
2. Misuse including mishandling, physical damage, improper installation – including battery, and unauthorized disassembly of the product
3. Water, exposure to solvents or any other liquid damage
4. Any unauthorised repair or modification
5. Power surges, lightning, fire, flood or other natural events
6. Use of the product with unauthorized third party products such as generic chargers
7. Any other cause beyond the range of normal usage for products

The End User shall have no right to reject, return, or receive a refund for any product under the above-mentioned situations.

Important Note:

Consult the warranty card for full information.

EXTRA BITS YOU SHOULD KNOW

SAFETY AND GENERAL INFORMATION

The handset contains delicate electronic circuitry, magnets and battery systems. Treat it with care and pay attention to the following points:

- Handle the handset with care. Do not drop or throw the handset.
- Do not immerse in any liquid. The handset contains a liquid detection sticker and the warranty will be voided by any liquid damage.
- Do not place the handset near computer disks, credit cards, and other magnetic media. The information contained on disks or cards may be erased or damaged.
- Do not leave the handset or battery in direct sunlight or near other heat sources where temperatures could exceed 45°C.
- Keep the handset, battery, charger and other accessories away from children.
- In the unlikely event of a battery leak avoid contact with your eyes or skin. Flush with water and consult a doctor.
- Observe and obey warning signs at petrol stations, airports and hospitals.
- The operation of some medical electronic devices, such as hearing aids and pacemakers, may be affected by the handset.
- Take care not to allow metal

objects such as coins or keys to come into contact with the battery terminals.

- Do not dispose of batteries in a fire.
 - Do not throw used batteries into household rubbish, return them to a recycling point
 - Do not connect the handset to non genuine or 3rd party chargers.
 - Only use the supplied charger.
 - Be careful not to pierce the battery with sharp objects and do not use damaged batteries.
 - Do not disassemble or modify the battery.
 - Stop using the battery if abnormal heat, odour, discolouration, deformation, or abnormal condition is detected during use, charge, or storage.
- Do not put the battery in your mouth.
 - Only use original replacement batteries.
 - Do not attempt to dismantle the handset or any of its accessories.
 - Do not place the handset close to the edge of a table in case it moves when set on vibrate mode.
 - Do not put the handset into a microwave oven, dryer, or high-pressure container.
 - Don't use the handset immediately after a sudden temperature change eg. from an air conditioned environment to high temperature and humidity outside. In such cases there could be condensing moisture inside the handset which can cause internal damage. Switch off and leave for 30 minutes

before use.

- Do not use the handset while driving or operating other machinery.
- Do not use the handset where blasting is in progress.
- Switch the phone off when boarding aircraft.
- Do not leave the handset at the bottom of a bag where it may be damaged by sharp objects.
- At high volume, prolonged listening to audio devices can cause hearing loss.
- Do not leave the handset discharged or disconnected for a long time, otherwise your personal data may be lost.
- Remember to make backup copies of all important data on the handset.
- Take care when the phone is in your pocket. Sitting down may damage the handset.
- It is normal for the handset to become warm while the battery is being charged.
- Under poor network conditions battery life is considerably reduced.
- When the battery is thrown away cover the terminals with insulating tape.
- Please recycle the packaging and all parts
- Emergency service coverage is dependent on network availability and battery status.
- It is always good practice to switch off the handset regularly.
- Do not expose the handset to oils

or solvents.

- If you have an alarm or calendar event set the handset switches on at the prescribed time.
- Your device is locked to the Skinny network. Contact Skinny to obtain the unlock code and instructions.

WARNINGS AND SAFETY NOTICES

Please read all the safety notices before using this device.

Do not use the phone near fuel or chemicals or in any prescribed area such as service stations and refineries.

Do not transport or store flammable gas, liquid or explosives in the same compartment of your vehicle as your mobile phone and accessories.

No part of this publication may be excerpted, reproduced, translated or utilized in any form or by any means, electronic or mechanical, including photocopying and microfilm, without the prior written permission of ZTE Corporation.

ZTE Corporation operates a policy of continuous development. We reserve the right to make changes and improvements to any products without prior notice.

LIMITATION OF LIABILITY

ZTE shall not be liable for any loss of profits or indirect, special, incidental or consequential damages resulting from or arising out of or in connection with using this product, whether or not ZTE had been advised, knew or should have known the possibility of such damages. Refer to the warranty card for full warranty and service information.

RF SAFETY INFORMATION

The handset has an internal antenna located at the top of the phone. For optimum performance with minimum power consumption do not cover the antenna area with your hand. Hold the handset between thumb and finger in the middle of the device. Covering the antenna affects call quality, may cause the handset to operate at higher power level than needed, and may shorten talk and idle times.

RADIO FREQUENCY ENERGY

The handset is a low-power radio transmitter and receiver. When switched on it intermittently transmits radio frequency (RF) energy (radio waves). The transmit power level is optimized for best performance and automatically reduces when there is good quality reception. Maximum power is only used at the edge of network coverage so under most circumstances the power output is very low. Under poor network conditions the phone transmits at a higher power, may get hot and have a significantly shorter battery life.

